

Yhdyskuntarakentamisen pilaantumattomien ylijäämäma-  
ainesten hyötykäyttö pellonparannuksissa 25.11.2021



## ”Putki,- kaivo ym. tarvikevalinnat eri pellonparannuskohteissa”



Kari Kohtala, rak.ins



Euroopan maaseudun  
kehittämisen maatalousrahasto:  
Eurooppa investoi maaseutualueisiin



## **Jita Oy:**

-Perustettu 1979 (Jukka Immonen&Teuvo Arpiainen)

Liikevaihto: 20me

Työntekijät: 40-50

Alihankkijat: n 30 henk

Tj: Kari Kohtala

Toiminta: Muoviputkien valmistus ja myynti  
Jätevesi- ja kuivatustuotteiden sekä erilaisten  
muovituotteiden valmistuttaminen ja myynti

Putkituotanto: 6 milj kg (rakenneseinämäiset putket)



# Mitä teemme?

- **Salaoja- ja rumpuputket**
  - Luokat: SN4, SN8 ja SN16
  - Koot: 110-1360mm
- **Kaapelinsuojaputket ja tarvikkeet**
  - Luokat A ja B
- **Jätevedenkäsittely**
  - Sakojärjestelmät
  - Umpisäiliöt
  - Jita Kemik -panospuhdistamo
  - Pumppaamot
  - In-Drän-moduulit , Embivalus
- **Kuivatusjärjestelmät**
  - Sv-kaivot
  - Salaoja- ja rännikaivot
- **Tieturvatuotteet**
  - Auraviitat
  - Reunapaalut
  - Havainnepylväät
- **Muut tuotteet**
  - Laiturituotteet,  
(Kompostori, kuivakäymälä)

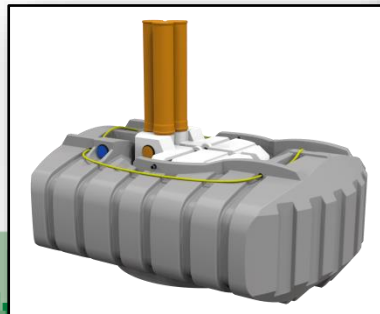



## Tuplaputkien pääasialliset käyttökohteet

**Maatalous: Peltorummut, salaojat, sadevesiviemärit**







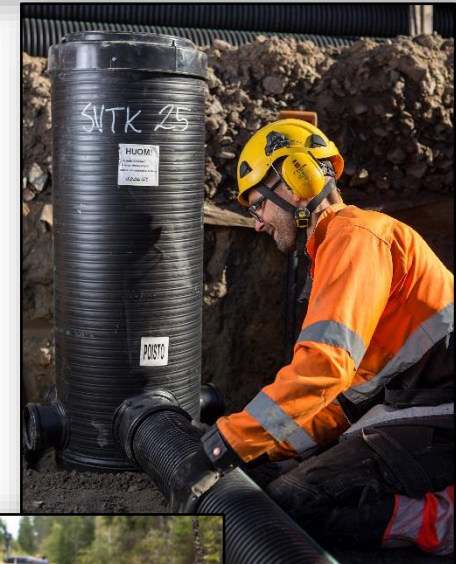



Maanrakennus: Salaojat, sadevesilinjat, rummut

Kaapelinsuojaus: tele- ja sähkökaapelien putkitus

Talonrakennus: Salaojat, ränni- ja pihavesien johtaminen



# Jita Oy, Putkikoot 2021

Koko (ø ulko/sisä)	SN4 6m	SN8 6m	SN4 SO	SN8 SO	SN8 8m	SN8 10m	Tel A (SN16)	Tel B (SN8)
50/40							X	
75/62							X	X
110/92	X	X	X	X				
140/124							X	X
160/140	X	X		X			X	X
168/150 		X		X				
200/176 	X	X	X	X	X			
235/200	X	X	X		X	X	x	
250/220 	X	X	X	X	X			
284/250 		X		X				
315/270 	X	X	X	X	X	X		
347/300	X	X	X		X	X		
400/344 	X	X	X	X	X	X		
450/400 	X	X	X		X	X		
560/500 	X	X			X	X		
684/600 	X	X			X	X		
902/800 	X	X			X	X		
1154/1000		X			X	X		
1360/1200		X						



## Lujuusluokat

- SN4: maatalous, viheralueet
- SN8: tien- ja kadunrakennus, maanrakentaminen
- SN16: erikoiskohteet, valikoima suppea

## Peitesyvyys

- 0,5...5m SN4 ja SN8
- SN8 min. 0,4m

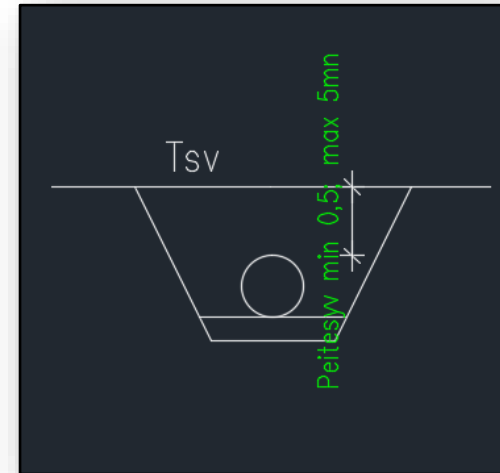

## Muita ominaisuuksia

- Höyrystulatus: kestää
- UV suoja: ON
- Pituudet: 6m jatkomuhvilla
- 8m ja 10m muhviton

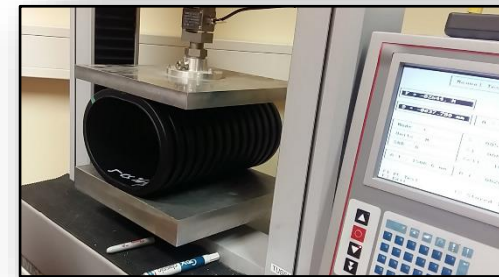

# Karkea mitoitus/ pelto /metsä

## Mitoitusvesimäärä

Pelto 1l/s/ha

Metsä 2l/s/ha

Pelto	1 l/s/ha		
Metsä	2 l/s/ha		
Mitoitusvesimäärä l/s			
ha(100mx100m)	pelto l/s	metsä l/s	
10	10	20	
20	20	40	
50	50	100	
100	100	200	
150	150	300	
200	200	400	
500	500	1000	
1000	1000	2000	

## Putken karkea mitoitus

2:Putken mitoitus :		putken sisämitta mm		
l/sek		1 %	2 %	4 %
80		315	250	250
150		450	400	400
250		600	500	500
500		800	600	600
1000		1000	1000	800



# Putkeen kohdistuvat voimat:

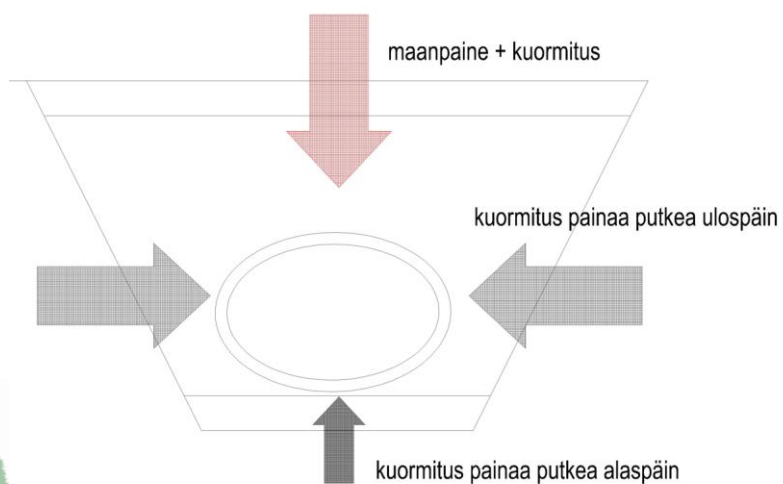
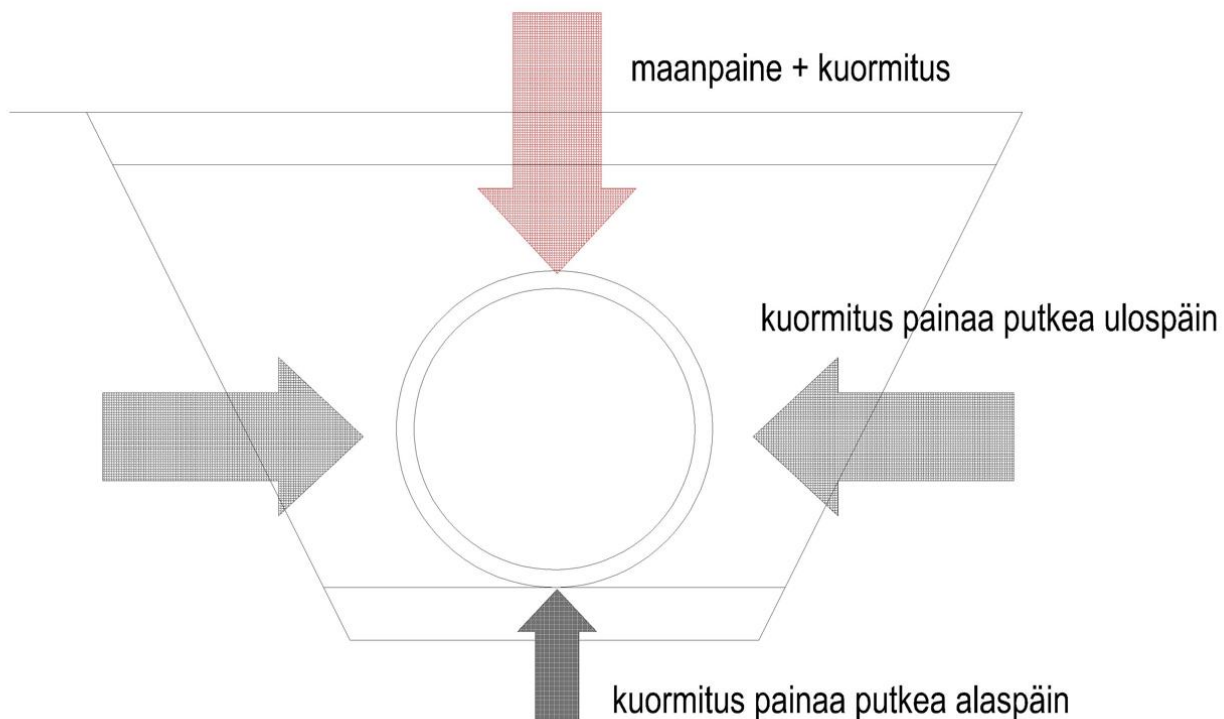



## Ylijäämämassojen käyttö putken asentamisessa:

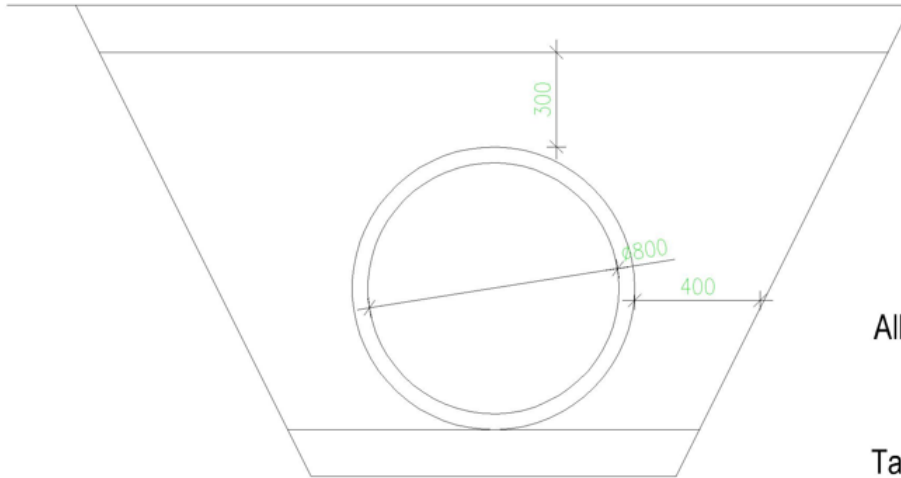

Alkutäyttö 95%

Tasauskerros 90%

Putkea vasten ei teräviä jakeita: max 16mm  
Suojaet. 30cm

Ulkopuolella sallittu (muoviputken asentamiseen liittyen)  
kaikki tiivistettävissä oleva materiaali

Yleisesti: asentamiseen pätee samat säännöt kun rakennettaessa hiekka,  
murske, sora jne...

**HUOM:**

Pyöreä ja tasarakeinen ei tiivisty  
Karkearakeinen kiilaus hienompirakeisella

# Yhteet/kaivot

runko 30% suurempi kuin suurin yhde (huom ulkomitta)

SVK 315/200

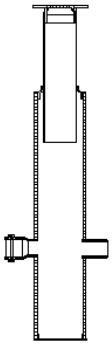

SVK 400/345/315

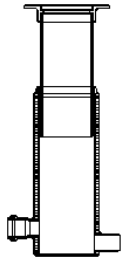

SVK 560/500

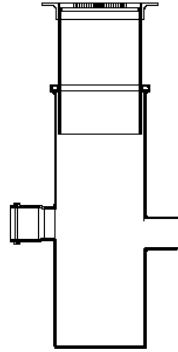

SVK 800/560/500

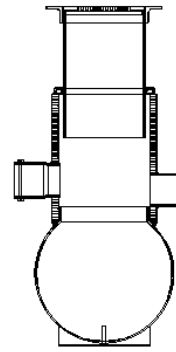

SVK 1000/560/500

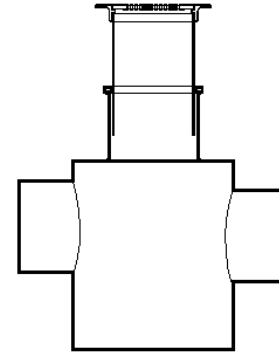

SVK 1400/560/500

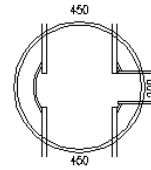
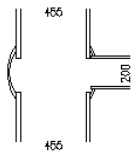
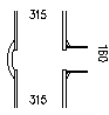
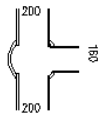
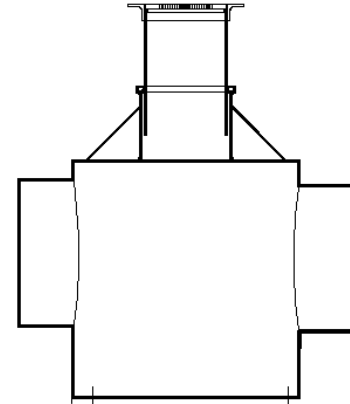

1000

max yhteet kun liitas samassa tasossa



## Satulakaivo Isotupla 800 ja 1000 putkelle:

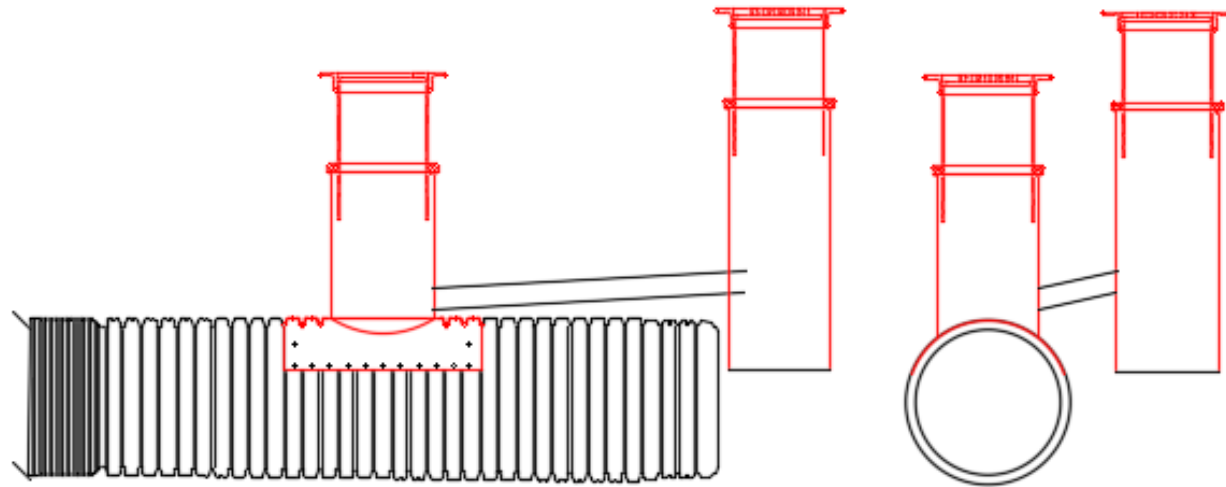

# Hulevesien käsittely:

Laskeutus

Kemikaliointi

Viivytys



# Ympäri vuotinen kemikalointi ja pystylaskeutus - ilman ulkoista energiaa

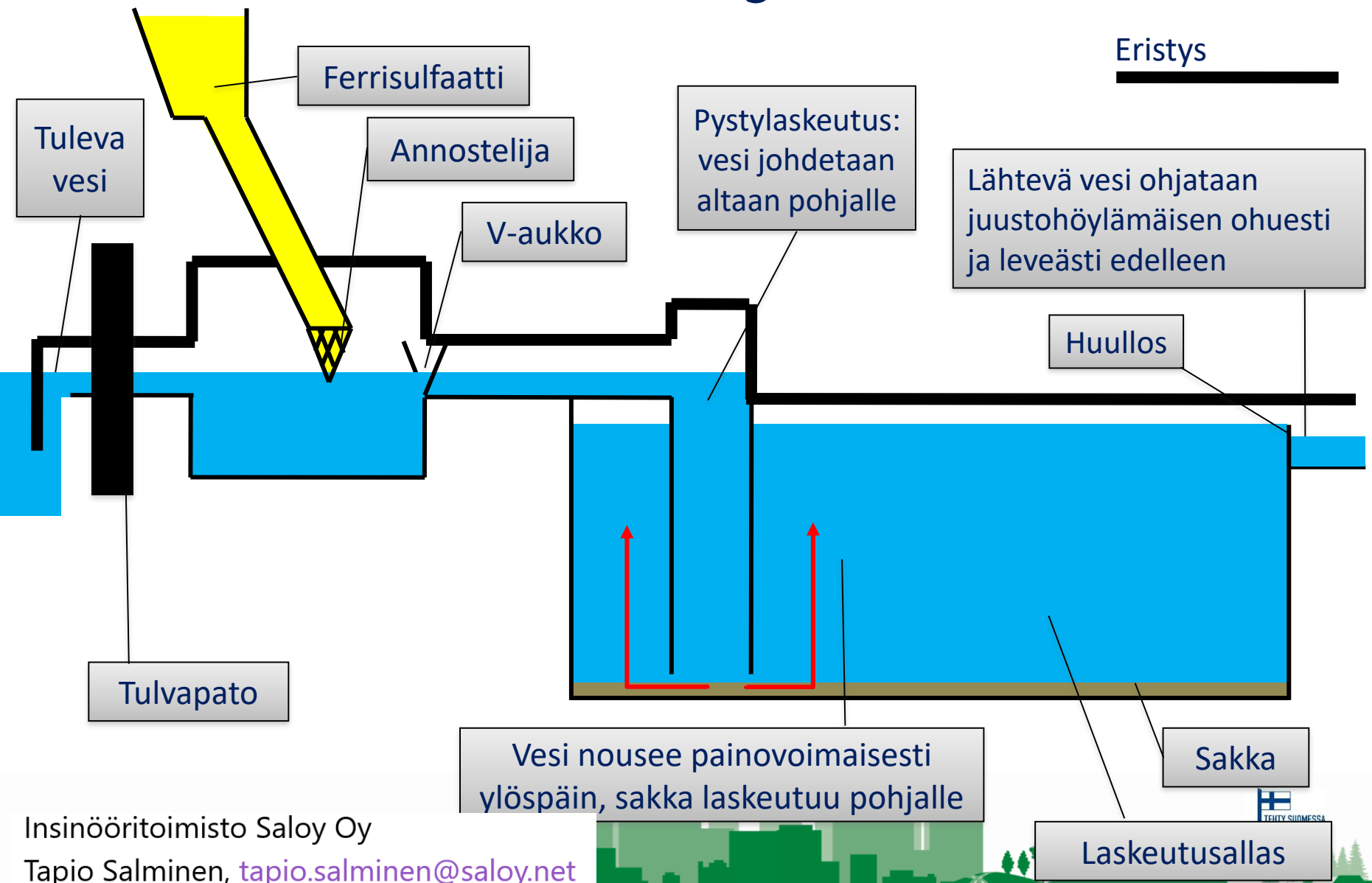



## Humuksen ja fosforin poisto ferrisulfaatilla:

Ferri	0,5kg	(0,6€)
Puhdistaa vettä	25m <sup>3</sup>	

Reduktiot P	80%
-------------	-----

Insinööritoimisto Saloy Oy

Tapio Salminen, [tapio.salminen@saloy.net](mailto:tapio.salminen@saloy.net)



# RAKI-hanke, Pien-Saimaa

## Kemikalointi ja ylempi laskeutusallas



Insinööritoimisto Saloy Oy  
Tapio Salminen, [tapio.salminen@saloy.net](mailto:tapio.salminen@saloy.net)





Jita Oy  
Lakarintie 10, 34800 Virrat  
Puhelin (Vaihe): 03 475 6100  
info@jita.fi  
etunimi.sukunimi@jita.fi



## MYNNIN YHTEYSTIEDOT



**Sebastian Yritys**  
Aluemyyntipäällikkö:  
Pohjanmaa  
(03) 475 6125  
0400 150 571



**Matti Listenmaa**  
Myyntijohtaja  
Myynti: Pirkanmaa  
(03) 475 6134  
0400 492 437



**Jesse Vaali**  
Aluemyyntipäällikkö:  
Länsi-Suomi  
(03) 475 6120  
040 843 9867

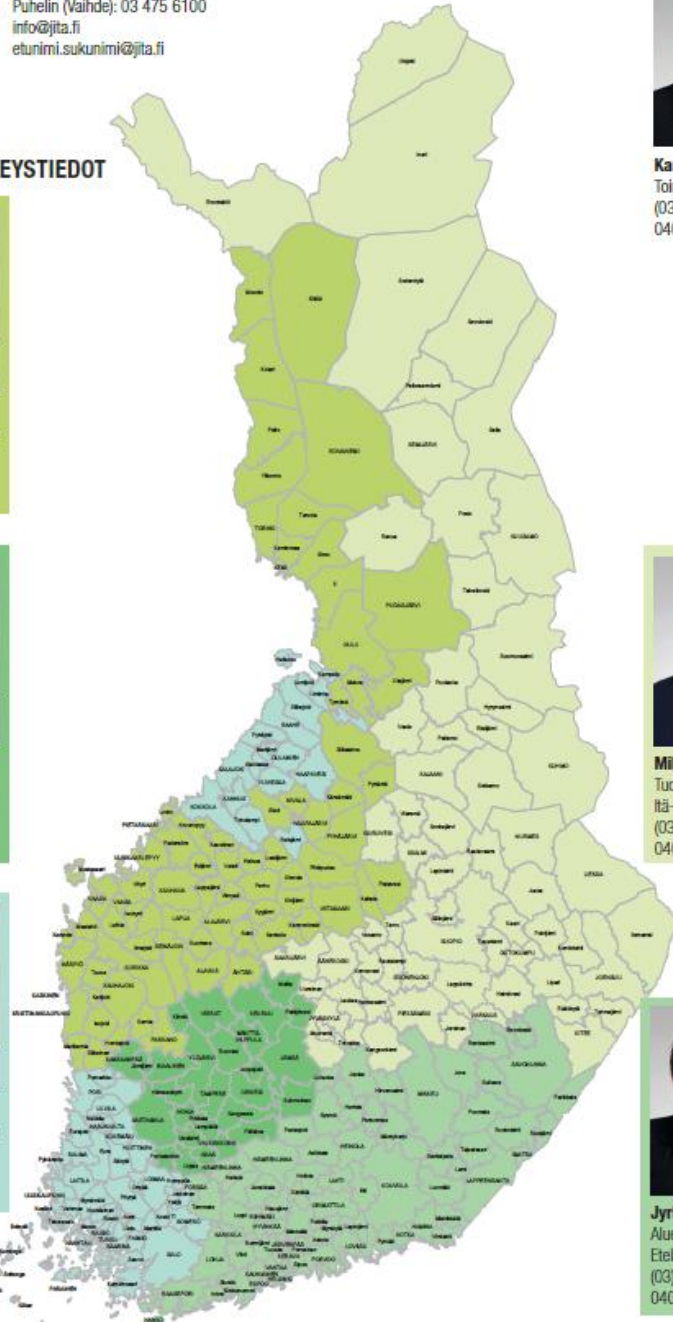

**Kari Kohtala**  
Toimitusjohtaja  
(03) 475 6129  
040 541 2625



**Mika Mäntysalmi**  
Tuotepäällikkö:  
itä-Suomi  
(03) 475 6118  
0400 474 846



**Jyrki Korhonen**  
Aluemyyntipäällikkö:  
Etelä-Suomi  
(03) 475 6113  
0400 836 161

